



HDMI/ KVM Extender Series

# User Manual

---

Model : HKM01-4K

4K HDMI USB/Audio/RS232/IR CAT5e KVM Extender 140M with  
Fiber



## Introduction

HKM01-4K is a 4K HDMI KVM extender that use a cost-effective Ethernet cable to send HDMI, USB, Analog audio, RS232, and IR signals with transmission distance up to 140 meters. Its TX unit has an HDMI loop out port for an extra HDMI display. The built-in 4 USB2.0 ports at RX unit allow you to control the connected HDMI device at remote end. The KVM extender can perfectly apply to the broadcasting system, digital signage, home network integration, industrial control...etc.

## Features

- Resolutions up to 4K 30Hz 4:4:4.
- Signal extension up to 120M over CAT5e, 140M over CAT6.
- 60KM over single mode fiber optic.
- Built-in local loop out for an extra HDMI display at TX side.
- Built-in 4 USB ports at RX unit.
- Supports bi-directional analog audio transmission for microphones and headphones.
- Supports IR, RS232 transmission and EDID management.
- Workable with SR01X (IP repeater) for longer distance.

## Diagram

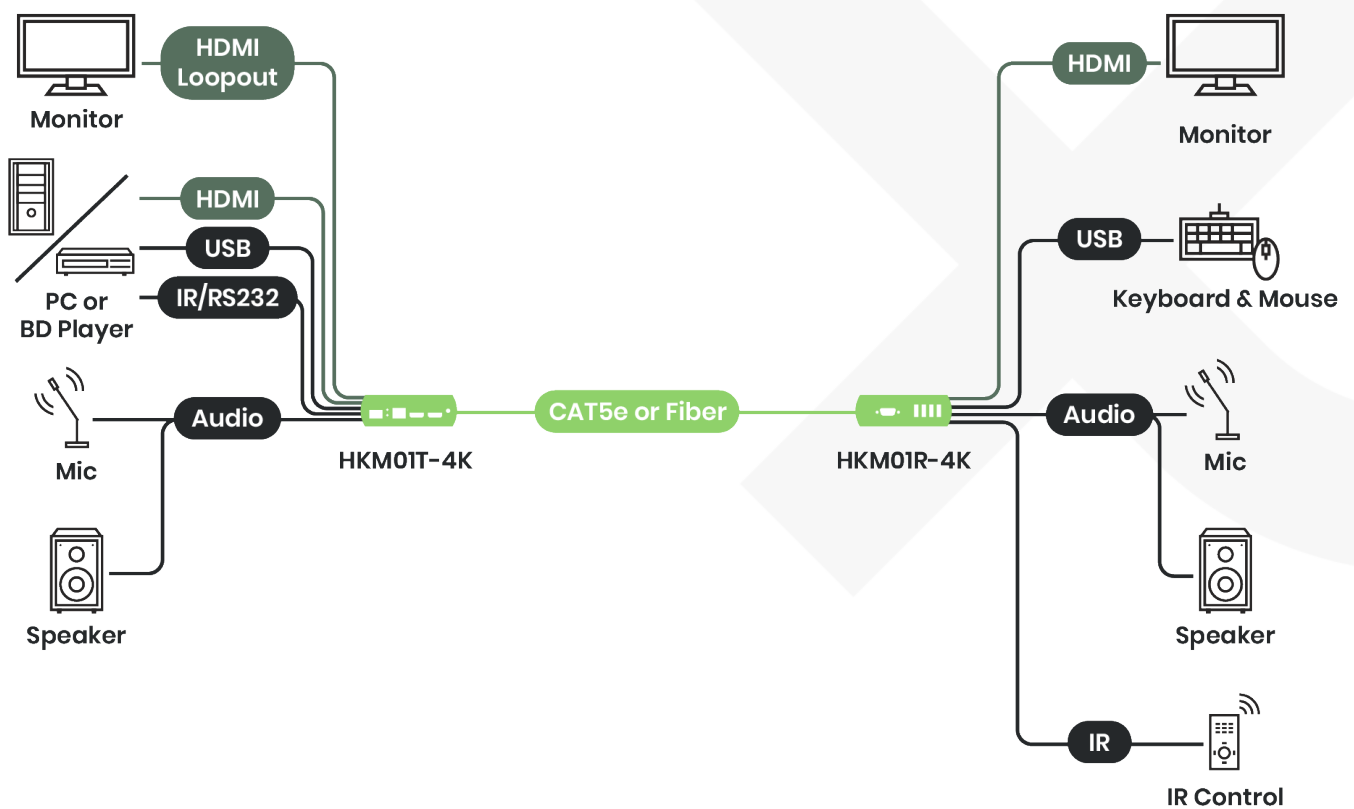

## Panel View

HKM01T-4K

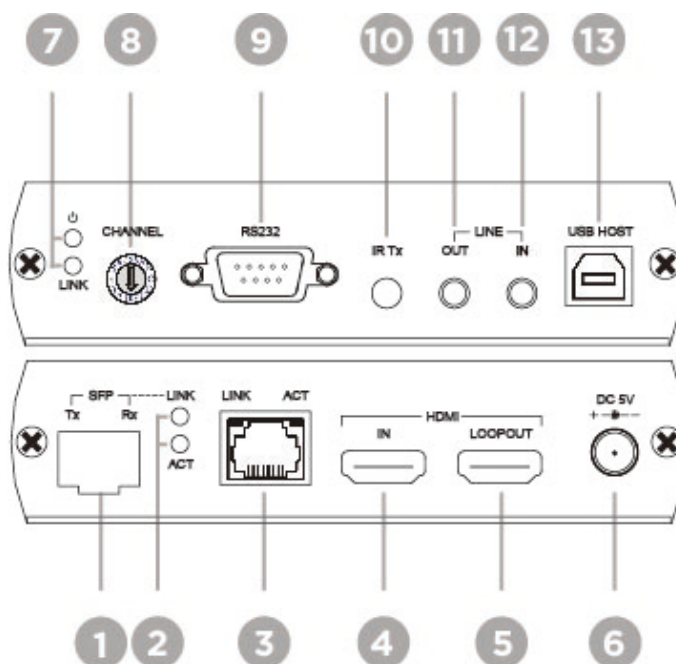

No.	Interface	Function
1	SFP Connector	To insert a SFP transceiver module
2	LINK/ACT	To indicate the status of SFP link and data transmission
3	RJ45 Connector	To connect HKM01T-4K/ HKM01R-4K
4	HDMI IN	To connect a HDMI source
5	HDMI LOOPOUT	To connect a HDMI display
6	Power Supply	To plug in DC 5V power adapter
7	Power/LINK	To indicate the status of Power and LINK
8	Rotary Switch	To set up the grouping function
9	RS232	To connect a RS232-command-controllable device
10	IR Tx	To connect an IR emitter
11	LINE OUT	To connect a 3.5mm jack for a speaker
12	LINE IN	To connect a 3.5mm jack for a microphone
13	USB HOST	To connect an USB-B cable

HKM01R-4K

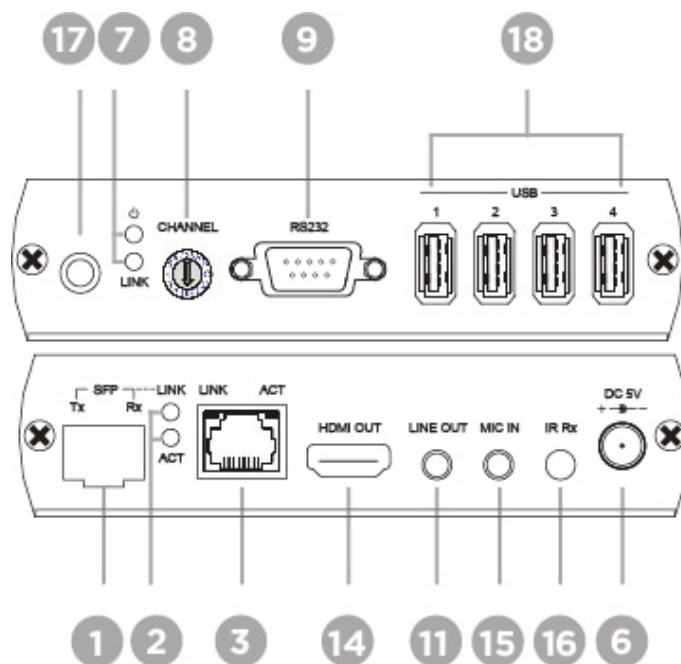

No.	Interface	Function
14	HDMI OUT	To connect an HDMI display
15	MIC IN	To connect a 3.5mm jack for a microphone
16	IR Rx	To connect a 3.5mm jack for an IR receiver
17	Internal IR receiver	To receive IR signal
18	USB	To connect an USB-A cable

## LED Indication

LED Indication	LED Color	Status
Power	Green On/ Off	Power On/ Off
Fiber Connection	Blue On/ Off	Fiber Linked/ Unlinked
RJ45 Connection	Green On/ Off	RJ45 Linked/ Unlinked
RJ45 Connection	Yellow On	Data Transferring

## Bottom View

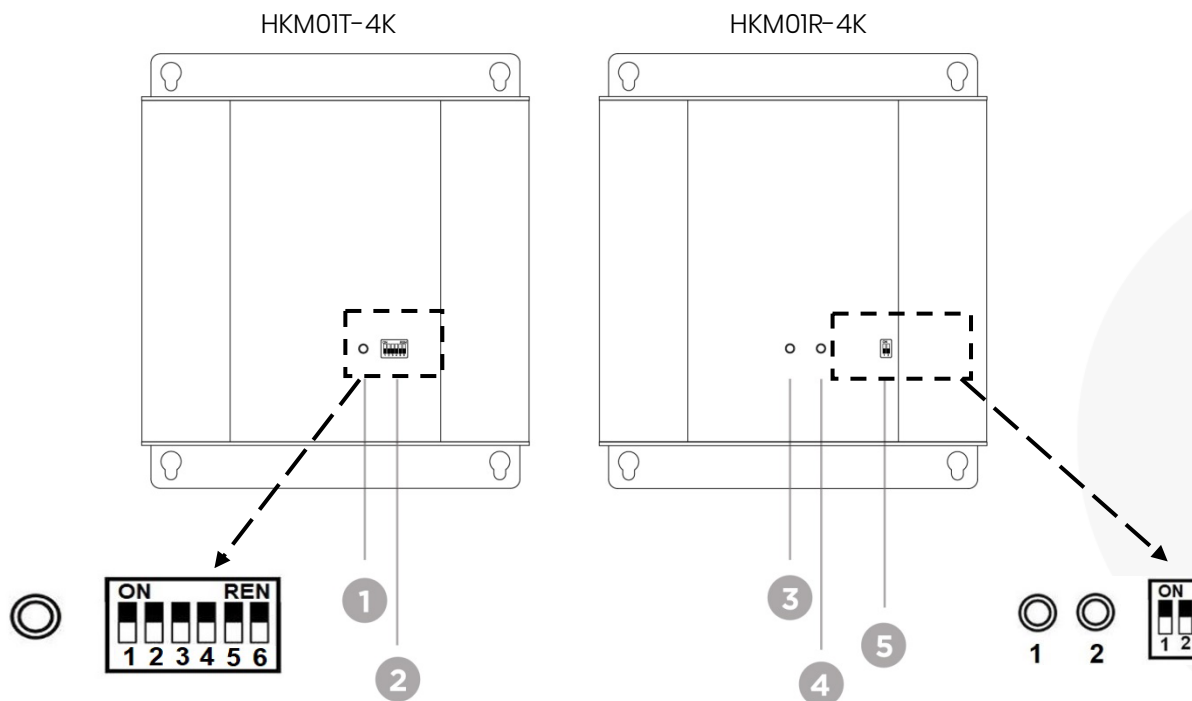

No.	Interface	Function
1	Tx Button 1	To set up EDID
2	Tx DIP Switch	To set up Groups, RS232, and EDID
3	Rx Button 1	To check the status of MAC, IP, Baud Rate and EDID
4	Rx Button 2	To set up Baud Rate parameters
5	Rx DIP Switch	To set up Groups and to enable RS232 transmission

## RJ45 Pin Define

Pin	Color	Data
1	Orange-white	DATA0 +
2	Orange	DATA0 -
3	Green-white	DATA1 +
4	Blue	DATA2 +
5	Blue-white	DATA2 -
6	Green	DATA1 -
7	Brown-white	DATA3 +
8	Brown	DATA3 -

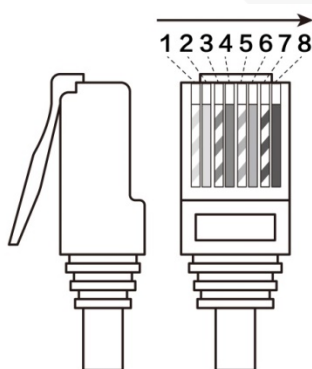

## RS232 Pin Define

Pin	DB9 (Male)	DB9 (Female)
1	CD	CD
2	RxD	TxD
3	TxD	RxD
4	DTR	DTR
5	GND	GND
6	DSR	DSR
7	RTS	RTS
8	CTS	CTS
9	RI	RI

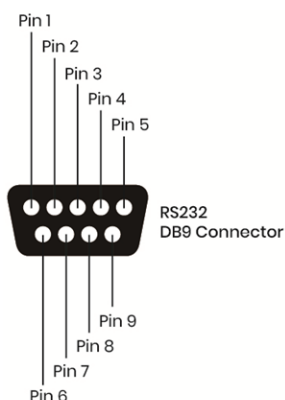

## Grouping

1. Set up the switch of Tx and Rx (HKM01T/R-4K) to choose a group.

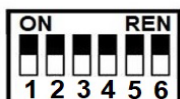

SWITCH	Group / Settings			
SW 1	Group 0	OFF ↑	Group 1	ON ↓

2. Set up the Channel
  - a. The channel of Tx and Rx in a same group should be the same.



(Up to 32 pairs of Tx and Rx can be set)

3. Remove the power and plug it in again.

## RS232 Setting

Refer to the instructions below to adjust the DIP switch.

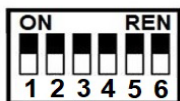

Tx (HKM01T-4K)		
SWITCH	Function	Settings
SW2	RS232 On	OFF ↑
SW3	(Default)	OFF ↑

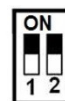

Rx (HKM01R-4K)		
SWITCH	Function	Settings
SW2	RS232 On	OFF ↑
	(Default)	

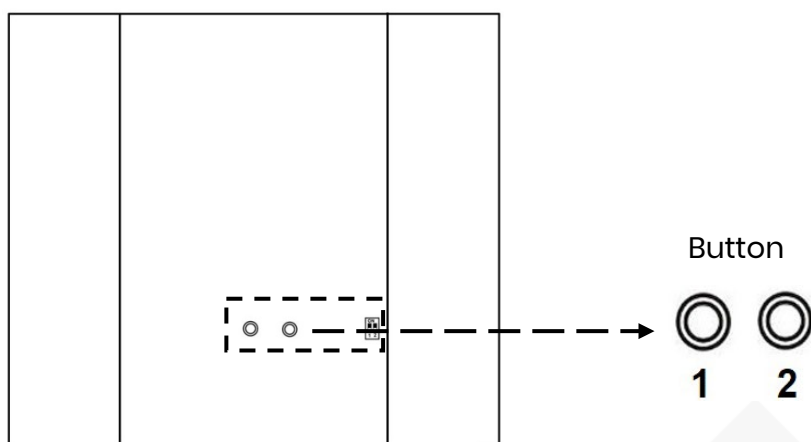

1. Check the bottom of the receiver (HKM01R-4K).
2. Press Button 1 to select a Baud Rate.
  - a. 115200 (Default), 57600, 38400, 19200, 14400, 9600, 4800, 2400, 1200bps.
3. Press Button 2 to choose parameter.
4. Press Button 1 again to confirm the change.

## EDID Setting

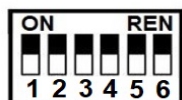

SWITCH	EDID Mode / Settings					
SW4	1080p 2CH (Default)	ON ↓	Copy the resolution from Rx side	OFF ↑	Copy the resolution from loop out side	ON ↓
SW5		ON ↓		ON ↓		OFF ↑

1. Remove all the HDMI cables.
2. Set up the DIP switch of Tx (HKM01T-4K).
3. Push the button at the bottom of the transmitter (HKM01T-4K).

## Digital /Analog Audio Conversion

Function	Transmitter LINE IN	Transmitter LINE OUT	Receiver MIC IN	Receiver LINE OUT	Description
Analog Bypass	O	O	O	O	Analog Audio IN, Analog Audio OUT (Monitor Audio Muted)
Audio Embedder	O	X	X	X	Analog Audio IN, HDMI Audio OUT
Audio Extractor	X	X	X	O	HDMI IN, Analog Audio OUT (support LPCM 2CH, monitor muted)
HDMI Bypass	X	X	X	X	HDMI IN, HDMI Audio OUT

O = Connected X = Disconnected

※When the receiver's "LINE OUT" or "MIC IN" is connected, the sound of monitor will be automatically muted.

## Trouble Shooting

- We strongly recommend using high quality CAT5e, CAT6 UTP/STP/FTP cable. Improper installation may cause unstable connection, and video & audio interruption.
- The highest data rate can be 850Mbps, which might affect other devices at the same LAN.
- Either UTP or SFP can be used as transmission medium.
- When the cable of external IR receiver connects to RX, the front panel IR will be disabled.
- Analog audio of Rx (MIC IN) is mono sound for microphone only, not stereo audio (Line in)
- Output power of USB is up to 500mA per port, 1500mA in total.
- RS232 does not support hardware handshake.

## Package Includes

Item	Amount
HKM01T-4K (Transmitter)	1 pc
HKM01R-4K (Receiver)	1 pc
DC 5V2A Power Adapter	2 pcs
IR Emitter Cable	1 pcs
USB A to B cable	1 pcs
Screw	8 pcs
Screw plug	8 pcs
Rubber gasket	2 pcs



## Specification

ITEM NO.	HKM01T-4K	HKM01R-4K
Support		
Compliance	HDMI 1.4 , HDCP 1.4, USB 2.0/ 1.1/ 1.0	
Max. Video Resolution	4K@30Hz	
Max. Transmission Distance	120M over CAT5e; 140M over CAT6; 60KM over single mode fiber optic	
Audio Format	LPCM7.1@192KHZ	
RS232 Baud Rate	115200bps	
IR Support	20-60Khz, ±45°, 5M	20-60Khz , ±45°, 5M
Ports & Interfaces		
Video Input	1 x HDMI Type A	1 x RJ45, 1 x SFP
Video Output	1 x RJ45, 1 x SFP	1 x HDMI Type A
Video Loop-out	1 x HDMI Type A	
Analog Audio Input	1 x (3.5mm) Stereo Phone Jack	1 x (3.5mm) Mono Phone Jack
Analog Audio Output	1 x (3.5mm) Stereo Phone Jack	1 x (3.5mm) Stereo Phone Jack
IR Receiver		1 x (3.5mm) Stereo Phone Jack
IR Emitter	1 x (3.5mm) Stereo Phone Jack	
RS232 Interface	1 x DB9 Female	1 x DB9 Male
USB Interface	1 x USB Type B	4 x USB Type A
Power		
Power Supply	DC 5V 2A	DC 5V 2A
Power Consumption	1200mA	400mA
Ambient Temperature		
Operation	0 to 55°C	
Storage	-20 to 85°C	
Humidity	Up to 95%	
Physical Characteristics		
Dimensions	125 x 140 x 30mm	125 x 140 x 30mm
Weight	380g	380g